

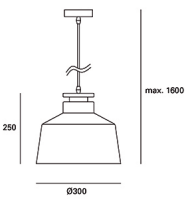

Nube Ø300mm

DE-0233-BLA

Colgante IP20 Nube Ø300mm E27 15 Blanco



CARACTERÍSTICAS TÉCNICAS



Potencia total luminaria : 15W

Voltaje / Frecuencia : 100-240V/50-60Hz

Material de la estructura : Acero, Madera

Garantía : 5 Años

Acabado estructura : Blanco

Luminaria fácilmente reciclable

Medida máx. de la bombilla : 200/NA mm

Bombilla recomendada : E27

CARACTERÍSTICAS LUMINOTÉCNICAS

Luminancia C0°G65°: 1330

Luminancia C90°G65°: 1377

Portalámparas	Cantidad	Potencia fuente de luz (W)
E27	1	Potencia máx. 15W

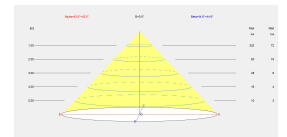
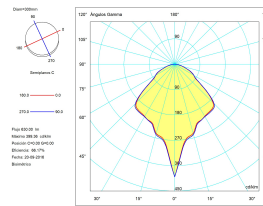

LOGÍSTICA

Peso neto (Kg): 1.43

Peso embalado (Kg): 2.29

Embalaje: 355mm x 350mm x 310mm





Luminaire

Code DE-0233-BLA
Name Colgante FORLIGHT 60W E27

Measur.

Code DE-0233-BLA
Name Colgante FORLIGHT 60W E27

Luminaire Flux	416.89 lm	Luminaire Power	42.00 W	Efficacy	9.93 lm/W	Efficiency	66.17%
Lamps Flux	630.00 lm	Maximum value	399.36 cd/klm	Position	C=0.00 G=0.00	CG	Double Symmetrical
Round Luminaire Round Luminous Area		Diam. Diam.	300 mm 298 mm	Height Height	267 mm 0 mm		
Horizontal Luminous Area Emitting area on Plane 0° Emitting area on Plane 90°		0.069746 m2 0.000000 m2 0.000000 m2		Emitting area on Plane 180° Emitting area on Plane 270° Glare area at 76°		0.000000 m2 0.000000 m2 0.016873 m2	
Coordinate system Date Measurement Distance		CG 20-09-2016 0.00		Symmetry Type Maximum Gamma Angle Measurement Flux		Double Symmetrical 90 630.00 lm	
Operator Temperature Humidity Notes		Asselum T2 25.00 °C 60.00 %		Source Voltage [V] Source current [A] Photocell			

Line		Code	Luminaire Lamps		Flux [lm]	Pow. [W]	Q.ty
		ECOCClassic 42W 230	Name	ECOCClassic 42W 230	630.00	42.00	1
C.I.E.	53 85 97 100 66		D DIN 5040		A40		
F UTE	0.66 D		B NBN		BZ 4		

Diam=300mm

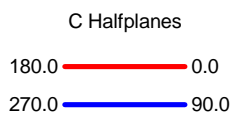
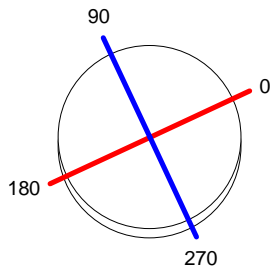

ULOR 0.00 %
DLOR 66.17 %
RN 0.00 %

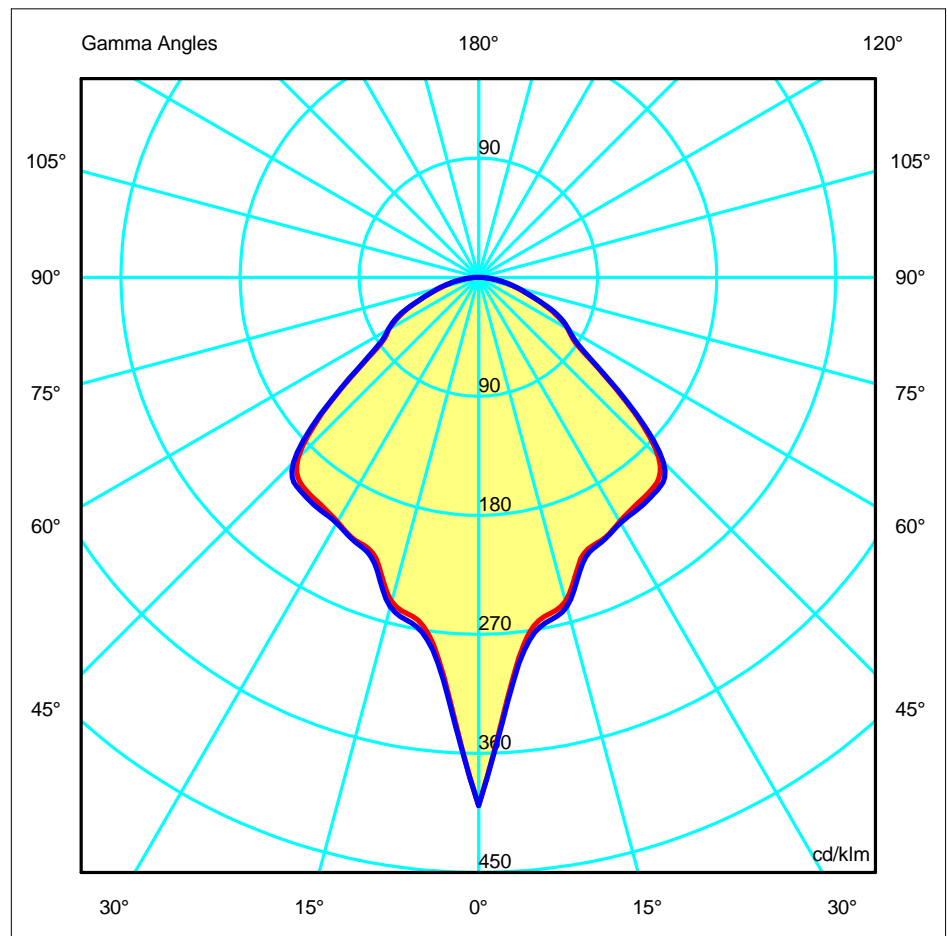



Luminaire

Code DE-0233-BLA
 Name Colgante FORLIGHT 60W E27

Measur.

Code DE-0233-BLA
 Name Colgante FORLIGHT 60W E27

Luminaire Flux	416.89 lm	Luminaire Power	42.00 W	Efficacy	9.93 lm/W	Efficiency	66.17%
Lamps Flux	630.00 lm	Maximum value	399.36 cd/klm	Position	C=0.00 G=0.00	CG	Double Symmetrical

Luminous Intensity Table cd/klm Table 1/1

	C 0.00	C 15.00	C 30.00	C 45.00	C 60.00	C 75.00	C 90.00
G 0.0	399.36	399.36	399.36	399.36	399.36	399.36	399.36
G 5.0	302.42	299.45	299.54	298.75	297.49	305.98	305.53
G 10.0	263.33	258.93	258.25	257.52	259.24	262.18	268.31
G 15.0	253.65	249.09	248.81	247.42	251.14	252.89	257.84
G 20.0	226.28	223.72	223.42	224.37	224.71	228.27	229.92
G 25.0	219.55	215.24	215.13	214.79	215.53	217.81	220.62
G 30.0	213.28	209.18	208.85	209.12	209.89	211.85	214.51
G 35.0	209.07	205.82	206.07	205.87	206.89	209.31	212.48
G 40.0	206.46	201.96	202.37	203.05	204.59	206.53	210.04
G 45.0	192.47	190.10	190.81	189.13	190.81	193.78	197.72
G 50.0	144.86	140.55	140.60	142.87	143.01	141.14	146.54
G 55.0	94.15	93.11	93.60	92.68	92.62	95.35	96.67
G 60.0	78.05	76.47	75.59	77.15	76.49	77.21	78.56
G 65.0	62.25	62.20	62.48	61.30	61.61	62.72	64.44
G 70.0	44.46	43.39	42.71	44.07	43.03	43.29	43.63
G 75.0	29.05	29.18	29.65	28.78	28.53	29.66	30.42
G 80.0	18.51	17.61	17.13	18.02	17.48	17.31	17.51
G 85.0	7.85	7.96	8.21	7.59	7.69	8.34	8.41
G 90.0	0.77	0.77	0.77	0.77	0.77	0.77	0.77

Luminaire

Code DE-0233-BLA
 Name Colgante FORLIGHT 60W E27

Measur.

Code DE-0233-BLA
 Name Colgante FORLIGHT 60W E27

Luminaire Flux	416.89 lm	Luminaire Power	42.00 W	Efficacy	9.93 lm/W	Efficiency	66.17%
Lamps Flux	630.00 lm	Maximum value	399.36 cd/klm	Position	C=0.00 G=0.00	CG	Double Symmetrical

Diam=300mm

C Halfplanes

180.0 ——— 0.0
 270.0 ——— 90.0

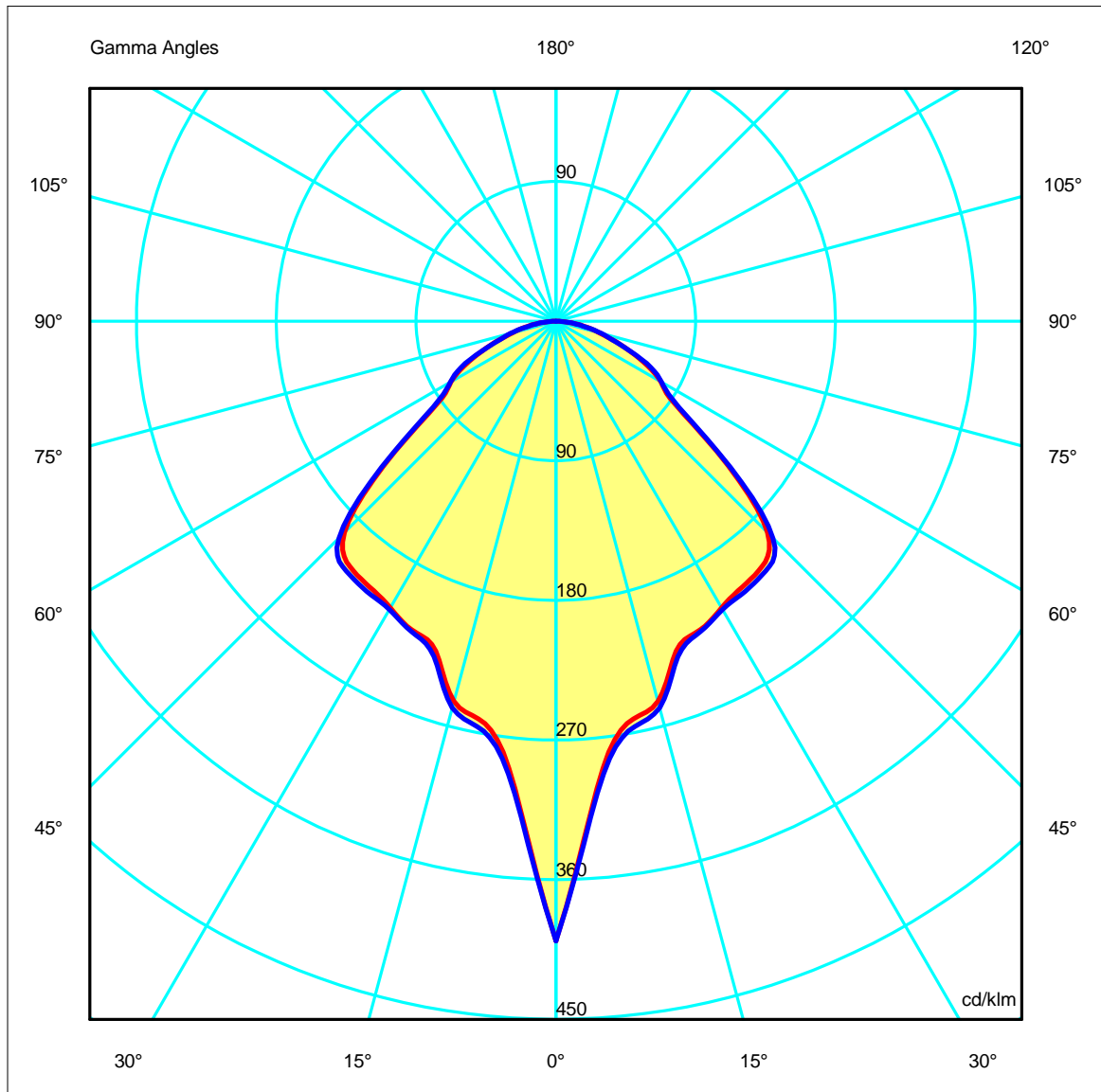
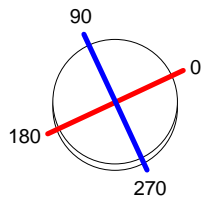

Luminaire

 Code DE-0233-BLA
 Name Colgante FORLIGHT 60W E27

Measur.

 Code DE-0233-BLA
 Name Colgante FORLIGHT 60W E27

Luminaire Flux	416.89 lm	Luminaire Power	42.00 W	Efficacy	9.93 lm/W	Efficiency	66.17%
Lamps Flux	630.00 lm	Maximum value	399.36 cd/klm	Position	C=0.00 G=0.00	CG	Double Symmetrical

Width at 50.00 % of Max Intensity

H[m]	1.00	2.00	3.00	4.00	5.00	H[m]	1.00	2.00	3.00	4.00	5.00
OA	0.95	1.90	2.84	3.79	4.74	OC	0.99	1.97	2.96	3.95	4.94
OB	0.95	1.90	2.84	3.79	4.74	OD	0.99	1.97	2.96	3.95	4.94

	Luminous Intensities [cd/klm]									
	0	5	15	25	35	45	55	65	75	85
OA	251.60	190.52	159.80	138.31	131.71	121.26	59.31	39.21	18.30	4.95
OB	251.60	190.52	159.80	138.31	131.71	121.26	59.31	39.21	18.30	4.95
OC	251.60	192.48	162.44	138.99	133.86	124.56	60.90	40.60	19.17	5.30
OD	251.60	192.48	162.44	138.99	133.86	124.56	60.90	40.60	19.17	5.30

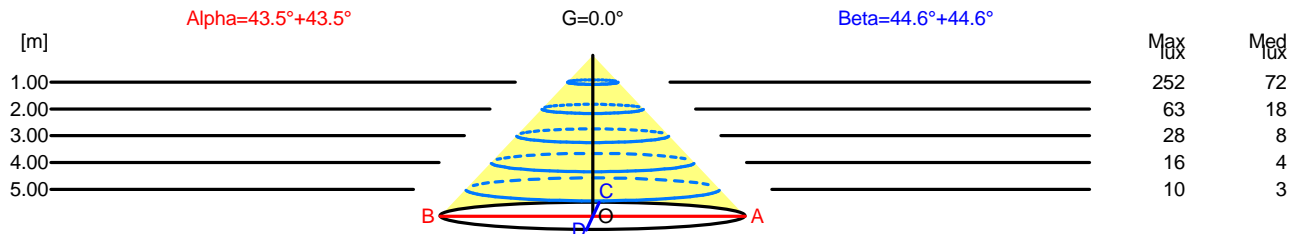

H[m]	D[m]	Max lux	Med lux	Alpha=43.5°+43.5°	G=0.0	
1.00	1.90	252	72			
2.00	3.79	63	18			
3.00	5.69	28	8			
4.00	7.58	16	4			
5.00	9.48	10	3			

H[m]	D[m]	Max lux	Med lux	Beta=44.6°+44.6°	G=0.0	
1.00	1.97	252	72			
2.00	3.95	63	18			
3.00	5.92	28	8			
4.00	7.90	16	4			
5.00	9.87	10	3			



Luminaire

Code DE-0233-BLA
Name Colgante FORLIGHT 60W E27

Measurement

Code DE-0233-BLA
Name Colgante FORLIGHT 60W E27

Luminaire Flux	416.89 lm	Luminaire Power	42.00 W	Efficacy	9.93 lm/W	Efficiency	66.17%
Lamps Flux	630.00 lm	Maximum value	399.36 cd/klm	Position	C=0.00 G=0.00	CG	Double Symmetrical

UGR
S = 0.250

Reflectancies										
Ceiling/Cavity	0.7	0.7	0.5	0.5	0.3	0.7	0.7	0.5	0.5	0.3
Walls	0.5	0.3	0.5	0.3	0.3	0.5	0.3	0.5	0.3	0.3
WorkingPlane	0.2	0.2	0.2	0.2	0.2	0.2	0.2	0.2	0.2	0.2
RoomDimensions	ViewedCrosswise					ViewedEndwise				
x=2H y=2H	13.9	15.2	14.2	15.4	15.7	14.0	15.2	14.3	15.4	15.7
x=2H y=3H	15.0	16.1	15.3	16.4	16.7	15.1	16.2	15.4	16.4	16.7
x=2H y=4H	15.4	16.5	15.8	16.8	17.1	15.5	16.5	15.8	16.8	17.1
x=2H y=6H	15.7	16.7	16.1	17.0	17.4	15.8	16.8	16.2	17.1	17.4
x=2H y=8H	15.9	16.8	16.2	17.1	17.5	15.9	16.8	16.3	17.1	17.5
x=2H y=12H	15.9	16.8	16.3	17.2	17.5	16.0	16.9	16.4	17.2	17.5
x=4H y=2H	14.4	15.5	14.8	15.8	16.1	14.5	15.5	14.8	15.8	16.1
x=4H y=3H	15.7	16.6	16.1	16.9	17.3	15.7	16.6	16.1	17.0	17.3
x=4H y=4H	16.3	17.0	16.7	17.4	17.8	16.3	17.1	16.7	17.4	17.8
x=4H y=6H	16.7	17.4	17.1	17.7	18.2	16.7	17.4	17.1	17.8	18.2
x=4H y=8H	16.9	17.5	17.3	17.9	18.3	16.9	17.5	17.3	17.9	18.3
x=4H y=12H	17.0	17.6	17.4	18.0	18.4	17.0	17.6	17.5	18.0	18.4
x=8H y=4H	16.5	17.1	16.9	17.5	18.0	16.5	17.2	17.0	17.6	18.0
x=8H y=6H	17.0	17.6	17.5	18.0	18.5	17.1	17.6	17.5	18.0	18.5
x=8H y=8H	17.3	17.7	17.8	18.2	18.7	17.3	17.8	17.8	18.2	18.7
x=8H y=12H	17.5	17.9	18.0	18.3	18.9	17.5	17.9	18.0	18.4	18.9
x=12H y=4H	16.5	17.1	17.0	17.5	17.9	16.5	17.1	17.0	17.5	17.9
x=12H y=6H	17.1	17.6	17.6	18.0	18.5	17.1	17.6	17.6	18.0	18.5
x=12H y=8H	17.4	17.8	17.9	18.2	18.7	17.4	17.8	17.9	18.3	18.7

Luminaire

Code DE-0233-BLA
 Name Colgante FORLIGHT 60W E27

Measur.

Code DE-0233-BLA
 Name Colgante FORLIGHT 60W E27

Luminaire Flux	416.89 lm	Luminaire Power	42.00 W	Efficacy	9.93 lm/W	Efficiency	66.17%
Lamps Flux	630.00 lm	Maximum value	399.36 cd/klm	Position	C=0.00 G=0.00	CG	Double Symmetrical

Diam=300mm

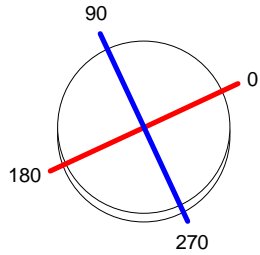

C Halfplanes

180.0 ———— 0.0
 270.0 ———— 90.0

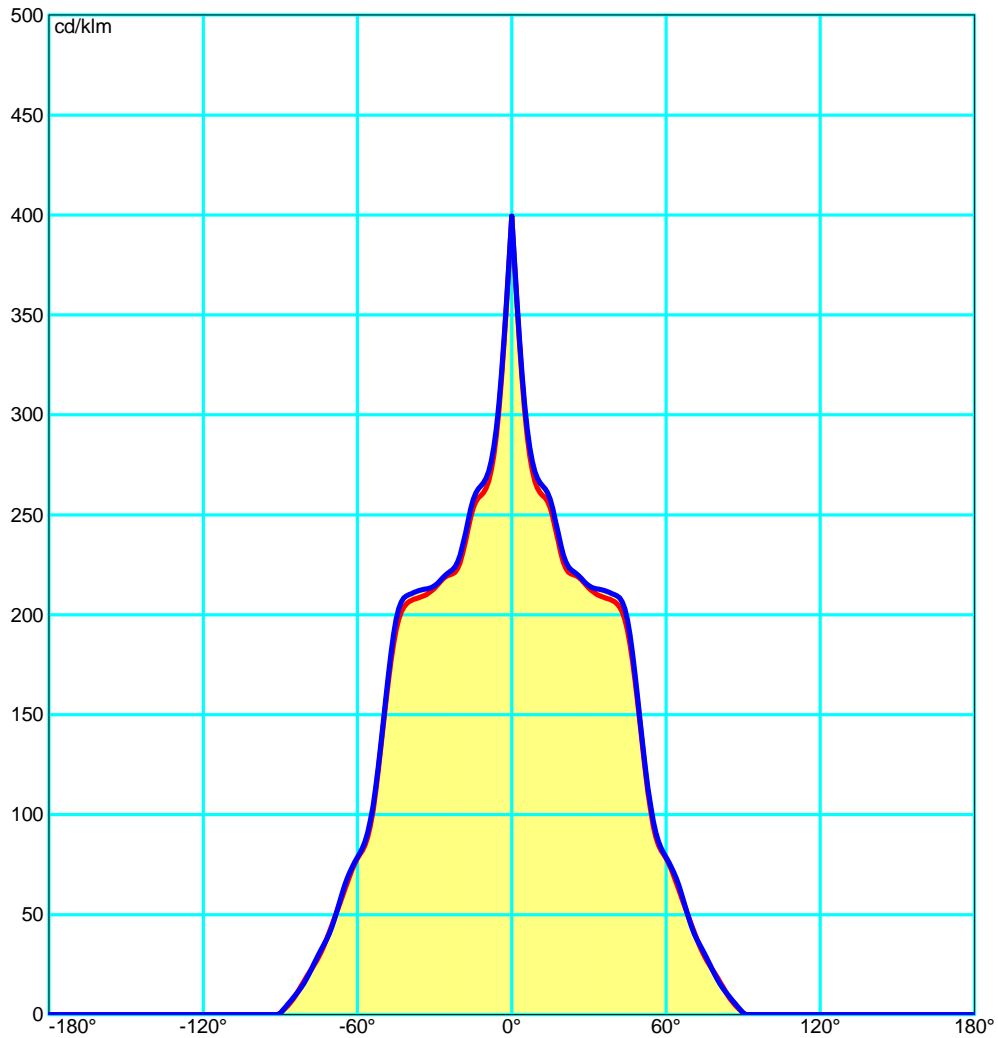

Luminaire

Code DE-0233-BLA
 Name Colgante FORLIGHT 60W E27

Measur.

Code DE-0233-BLA
 Name Colgante FORLIGHT 60W E27

Luminaire Flux	416.89 lm	Luminaire Power	42.00 W	Efficacy	9.93 lm/W	Efficiency	66.17%
Lamps Flux	630.00 lm	Maximum value	399.36 cd/klm	Position	C=0.00 G=0.00	CG	Double Symmetrical

Luminance

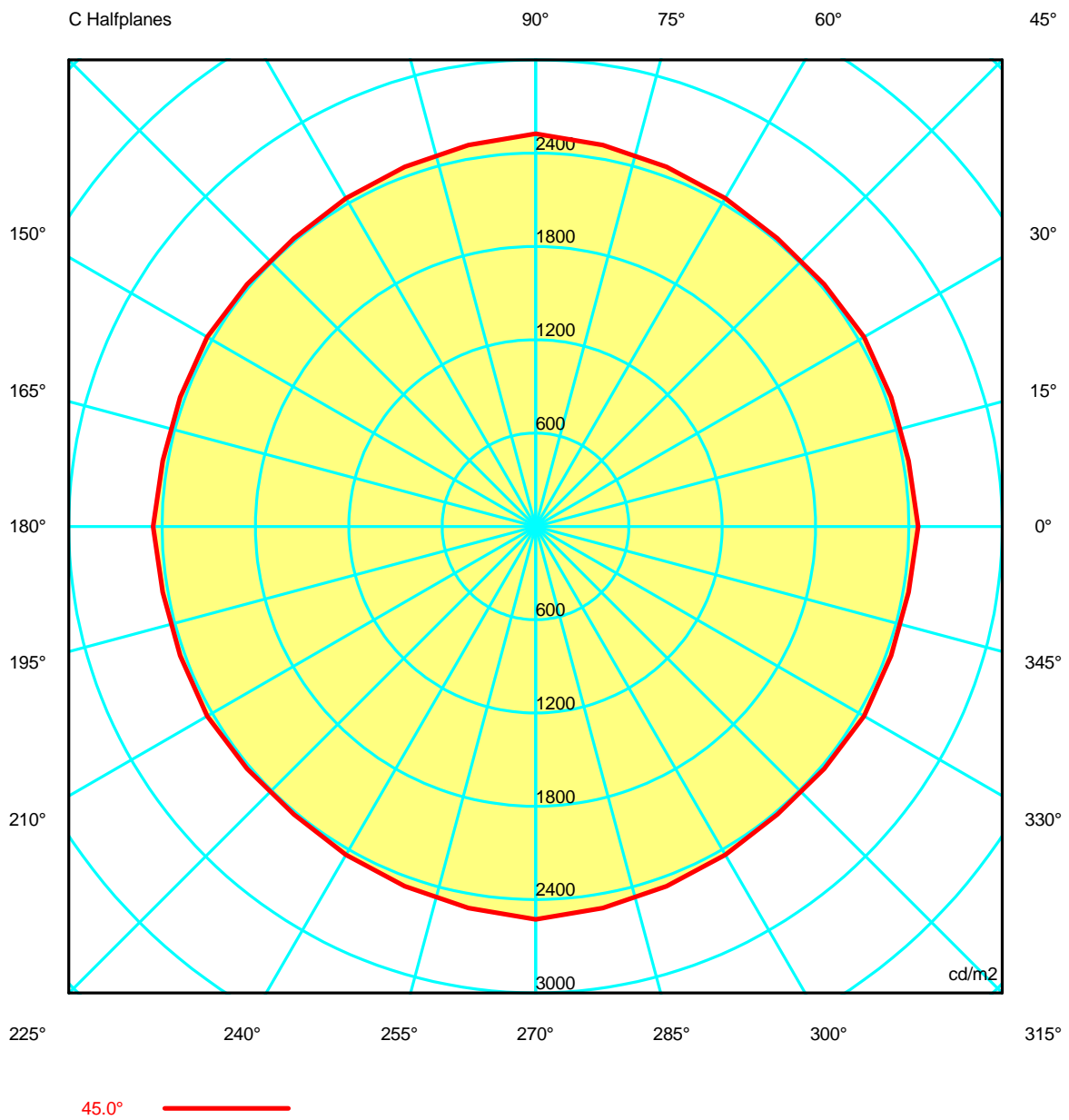



Luminaire

Code DE-0233-BLA
Name Colgante FORLIGHT 60W E27

Measurment

Code DE-0233-BLA
Name Colgante FORLIGHT 60W E27

Luminaire Flux	416.89 lm	Luminaire Power	42.00 W	Efficacy	9.93 lm/W	Efficiency	66.17%
Lamps Flux	630.00 lm	Maximum value	399.36 cd/klm	Position	C=0.00 G=0.00	CG	Double Symmetrical

Luminance cd/m2 Table 1/3

	C 0.00	C 10.00	C 20.00	C 30.00	C 40.00	C 50.00	C 60.00	C 70.00	C 80.00	C 90.00	C 100.00	C 110.00	C 120.00
G 0.0	3607.29	3607.29	3607.29	3607.29	3607.29	3607.29	3607.29	3607.29	3607.29	3607.29	3607.29	3607.29	3607.29
G 5.0	2742.09	2721.42	2715.46	2716.01	2714.85	2698.86	2697.37	2749.84	2783.40	2770.28	2783.40	2749.84	2697.37
G 10.0	2415.27	2384.84	2370.59	2368.73	2362.92	2364.92	2377.78	2393.19	2420.68	2460.99	2420.68	2393.19	2377.78
G 15.0	2371.99	2338.92	2326.80	2326.71	2314.63	2322.31	2348.46	2358.97	2376.45	2411.13	2376.45	2358.97	2348.46
G 20.0	2175.11	2156.94	2146.86	2147.60	2154.63	2157.85	2160.02	2182.34	2202.23	2210.11	2202.23	2182.34	2160.02
G 25.0	2188.10	2155.24	2144.84	2144.12	2141.96	2141.17	2148.10	2162.16	2179.94	2198.84	2179.94	2162.16	2148.10
G 30.0	2224.49	2192.27	2180.65	2178.37	2180.22	2182.67	2189.12	2201.61	2218.47	2237.38	2218.47	2201.61	2189.12
G 35.0	2305.35	2277.51	2270.52	2272.35	2270.88	2271.65	2281.31	2297.86	2319.16	2342.94	2319.16	2297.86	2281.31
G 40.0	2434.39	2393.36	2378.50	2386.23	2391.35	2399.20	2412.45	2426.16	2447.28	2476.69	2447.28	2426.16	2412.45
G 45.0	2458.71	2433.43	2430.71	2437.48	2422.10	2417.85	2437.47	2461.62	2490.91	2525.67	2490.91	2461.62	2437.47
G 50.0	2035.60	1990.09	1968.46	1975.83	1997.50	2014.24	2009.59	1992.10	1998.03	2059.30	1998.03	1992.10	2009.59
G 55.0	1482.65	1468.81	1468.33	1474.01	1465.97	1454.70	1458.61	1486.76	1511.73	1522.30	1511.73	1486.76	1458.61
G 60.0	1410.06	1391.23	1371.92	1365.64	1385.89	1392.77	1381.84	1387.34	1402.82	1419.22	1402.82	1387.34	1381.84
G 65.0	1330.39	1328.06	1331.41	1335.34	1318.15	1308.24	1316.71	1331.18	1351.65	1377.25	1351.65	1331.18	1316.71
G 70.0	1174.07	1156.19	1134.78	1127.90	1155.08	1159.37	1136.54	1137.66	1147.49	1152.21	1147.49	1137.66	1136.54
G 75.0	1014.01	1016.89	1025.71	1034.76	1016.80	995.78	995.67	1020.66	1046.30	1061.80	1046.30	1020.66	995.67
G 80.0	962.86	931.93	900.64	891.09	924.70	934.84	909.25	899.11	902.89	910.75	902.89	899.11	909.25
G 85.0	813.93	821.19	838.28	850.37	808.50	777.43	796.52	844.62	866.77	871.63	866.77	844.62	796.52
G 90.0	0.00	0.00	0.00	0.00	0.00	0.00	0.00	0.00	0.00	0.00	0.00	0.00	0.00



Luminaire

Code DE-0233-BLA
Name Colgante FORLIGHT 60W E27

Measurment

Code DE-0233-BLA
Name Colgante FORLIGHT 60W E27

Luminaire Flux	416.89 lm	Luminaire Power	42.00 W	Efficacy	9.93 lm/W	Efficiency	66.17%
Lamps Flux	630.00 lm	Maximum value	399.36 cd/klm	Position	C=0.00 G=0.00	CG	Double Symmetrical

Luminance cd/m2 Table 2/3

	C 130.00	C 140.00	C 150.00	C 160.00	C 170.00	C 180.00	C 190.00	C 200.00	C 210.00	C 220.00	C 230.00	C 240.00	C 250.00
G 0.0	3607.29	3607.29	3607.29	3607.29	3607.29	3607.29	3607.29	3607.29	3607.29	3607.29	3607.29	3607.29	3607.29
G 5.0	2698.86	2714.85	2716.01	2715.46	2721.42	2742.09	2721.42	2715.46	2716.01	2714.85	2698.86	2697.37	2749.84
G 10.0	2364.92	2362.92	2368.73	2370.59	2384.84	2415.27	2384.84	2370.59	2368.73	2362.92	2364.92	2377.78	2393.19
G 15.0	2322.31	2314.63	2326.71	2326.80	2338.92	2371.99	2338.92	2326.80	2326.71	2314.63	2322.31	2348.46	2358.97
G 20.0	2157.85	2154.63	2147.60	2146.86	2156.94	2175.11	2156.94	2146.86	2147.60	2154.63	2157.85	2160.02	2182.34
G 25.0	2141.17	2141.96	2144.12	2144.84	2155.24	2188.10	2155.24	2144.84	2144.12	2141.96	2141.17	2148.10	2162.16
G 30.0	2182.67	2180.22	2178.37	2180.65	2192.27	2224.49	2192.27	2180.65	2178.37	2180.22	2182.67	2189.12	2201.61
G 35.0	2271.65	2270.88	2272.35	2270.52	2277.51	2305.35	2277.51	2270.52	2272.35	2270.88	2271.65	2281.31	2297.86
G 40.0	2399.20	2391.35	2386.23	2378.50	2393.36	2434.39	2393.36	2378.50	2386.23	2391.35	2399.20	2412.45	2426.16
G 45.0	2417.85	2422.10	2437.48	2430.71	2433.43	2458.71	2433.43	2430.71	2437.48	2422.10	2417.85	2437.47	2461.62
G 50.0	2014.24	1997.50	1975.83	1968.46	1990.09	2035.60	1990.09	1968.46	1975.83	1997.50	2014.24	2009.59	1992.10
G 55.0	1454.70	1465.97	1474.01	1468.33	1468.81	1482.65	1468.81	1468.33	1474.01	1465.97	1454.70	1458.61	1486.76
G 60.0	1392.77	1385.89	1365.64	1371.92	1391.23	1410.06	1391.23	1371.92	1365.64	1385.89	1392.77	1381.84	1387.34
G 65.0	1308.24	1318.15	1335.34	1331.41	1328.06	1330.39	1328.06	1331.41	1335.34	1318.15	1308.24	1316.71	1331.18
G 70.0	1159.37	1155.08	1127.90	1134.78	1156.19	1174.07	1156.19	1134.78	1127.90	1155.08	1159.37	1136.54	1137.66
G 75.0	995.78	1016.80	1034.76	1025.71	1016.89	1014.01	1016.89	1025.71	1034.76	1016.80	995.78	995.67	1020.66
G 80.0	934.84	924.70	891.09	900.64	931.93	962.86	931.93	900.64	891.09	924.70	934.84	909.25	899.11
G 85.0	777.43	808.50	850.37	838.28	821.19	813.93	821.19	838.28	850.37	808.50	777.43	796.52	844.62
G 90.0	0.00	0.00	0.00	0.00	0.00	0.00	0.00	0.00	0.00	0.00	0.00	0.00	0.00



Luminaire

Code DE-0233-BLA
Name Colgante FORLIGHT 60W E27

Measur.

Code DE-0233-BLA
Name Colgante FORLIGHT 60W E27

Luminaire Flux	416.89 lm	Luminaire Power	42.00 W	Efficacy	9.93 lm/W	Efficiency	66.17%
Lamps Flux	630.00 lm	Maximum value	399.36 cd/klm	Position	C=0.00 G=0.00	CG	Double Symmetrical

Luminance cd/m2 Table 3/3

	C 260.00	C 270.00	C 280.00	C 290.00	C 300.00	C 310.00	C 320.00	C 330.00	C 340.00	C 350.00
G 0.0	3607.29	3607.29	3607.29	3607.29	3607.29	3607.29	3607.29	3607.29	3607.29	3607.29
G 5.0	2783.40	2770.28	2783.40	2749.84	2697.37	2698.86	2714.85	2716.01	2715.46	2721.42
G 10.0	2420.68	2460.99	2420.68	2393.19	2377.78	2364.92	2362.92	2368.73	2370.59	2384.84
G 15.0	2376.45	2411.13	2376.45	2358.97	2348.46	2322.31	2314.63	2326.71	2326.80	2338.92
G 20.0	2202.23	2210.11	2202.23	2182.34	2160.02	2157.85	2154.63	2147.60	2146.86	2156.94
G 25.0	2179.94	2198.84	2179.94	2162.16	2148.10	2141.17	2141.96	2144.12	2144.84	2155.24
G 30.0	2218.47	2237.38	2218.47	2201.61	2189.12	2182.67	2180.22	2178.37	2180.65	2192.27
G 35.0	2319.16	2342.94	2319.16	2297.86	2281.31	2271.65	2270.88	2272.35	2270.52	2277.51
G 40.0	2447.28	2476.69	2447.28	2426.16	2412.45	2399.20	2391.35	2386.23	2378.50	2393.36
G 45.0	2490.91	2525.67	2490.91	2461.62	2437.47	2417.85	2422.10	2437.48	2430.71	2433.43
G 50.0	1998.03	2059.30	1998.03	1992.10	2009.59	2014.24	1997.50	1975.83	1968.46	1990.09
G 55.0	1511.73	1522.30	1511.73	1486.76	1458.61	1454.70	1465.97	1474.01	1468.33	1468.81
G 60.0	1402.82	1419.22	1402.82	1387.34	1381.84	1392.77	1385.89	1365.64	1371.92	1391.23
G 65.0	1351.65	1377.25	1351.65	1331.18	1316.71	1308.24	1318.15	1335.34	1331.41	1328.06
G 70.0	1147.49	1152.21	1147.49	1137.66	1136.54	1159.37	1155.08	1127.90	1134.78	1156.19
G 75.0	1046.30	1061.80	1046.30	1020.66	995.67	995.78	1016.80	1034.76	1025.71	1016.89
G 80.0	902.89	910.75	902.89	899.11	909.25	934.84	924.70	891.09	900.64	931.93
G 85.0	866.77	871.63	866.77	844.62	796.52	777.43	808.50	850.37	838.28	821.19
G 90.0	0.00	0.00	0.00	0.00	0.00	0.00	0.00	0.00	0.00	0.00

Luminaire
 Code DE-0233-BLA
 Name Colgante FORLIGHT 60W E27
Measur.
 Code DE-0233-BLA
 Name Colgante FORLIGHT 60W E27

Luminaire Flux	416.89 lm	Luminaire Power	42.00 W	Efficacy	9.93 lm/W	Efficiency	66.17%
Lamps Flux	630.00 lm	Maximum value	399.36 cd/klm	Position	C=0.00 G=0.00	CG	Double Symmetrical

PERCENTAGE ISOCANDLES

Projection: Equal Area SLI (glare) 9.1 Tight Tilting Angle:0°

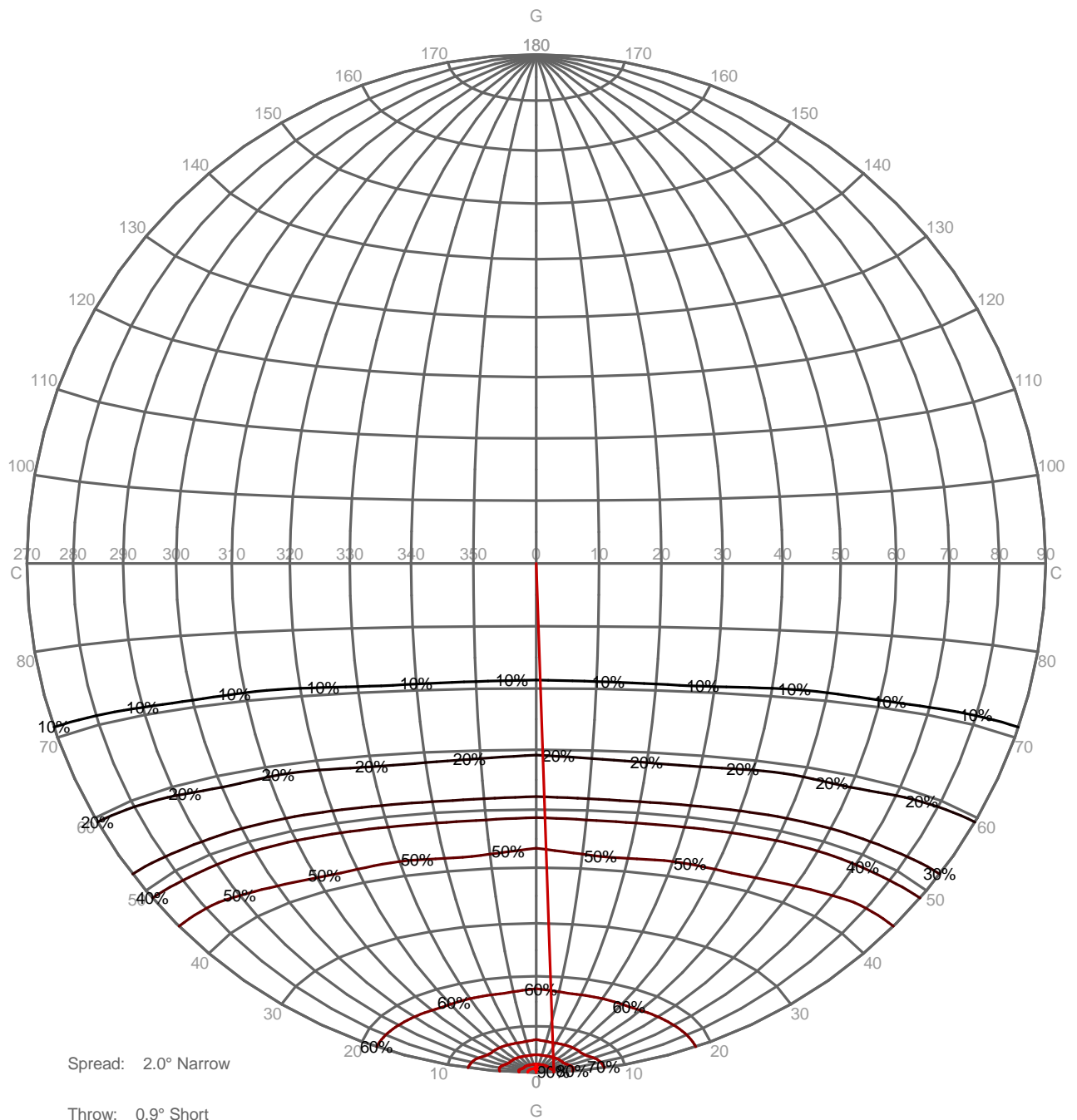

Luminaire

Code DE-0233-BLA
 Name Colgante FORLIGHT 60W E27

Measur.

Code DE-0233-BLA
 Name Colgante FORLIGHT 60W E27

Luminaire Flux	416.89 lm	Luminaire Power	42.00 W	Efficacy	9.93 lm/W	Efficiency	66.17%
Lamps Flux	630.00 lm	Maximum value	399.36 cd/klm	Position	C=0.00 G=0.00	CG	Double Symmetrical

Isolux (Floor)

Luminaire position X=0.00m Y=0.00m Z=2.50m

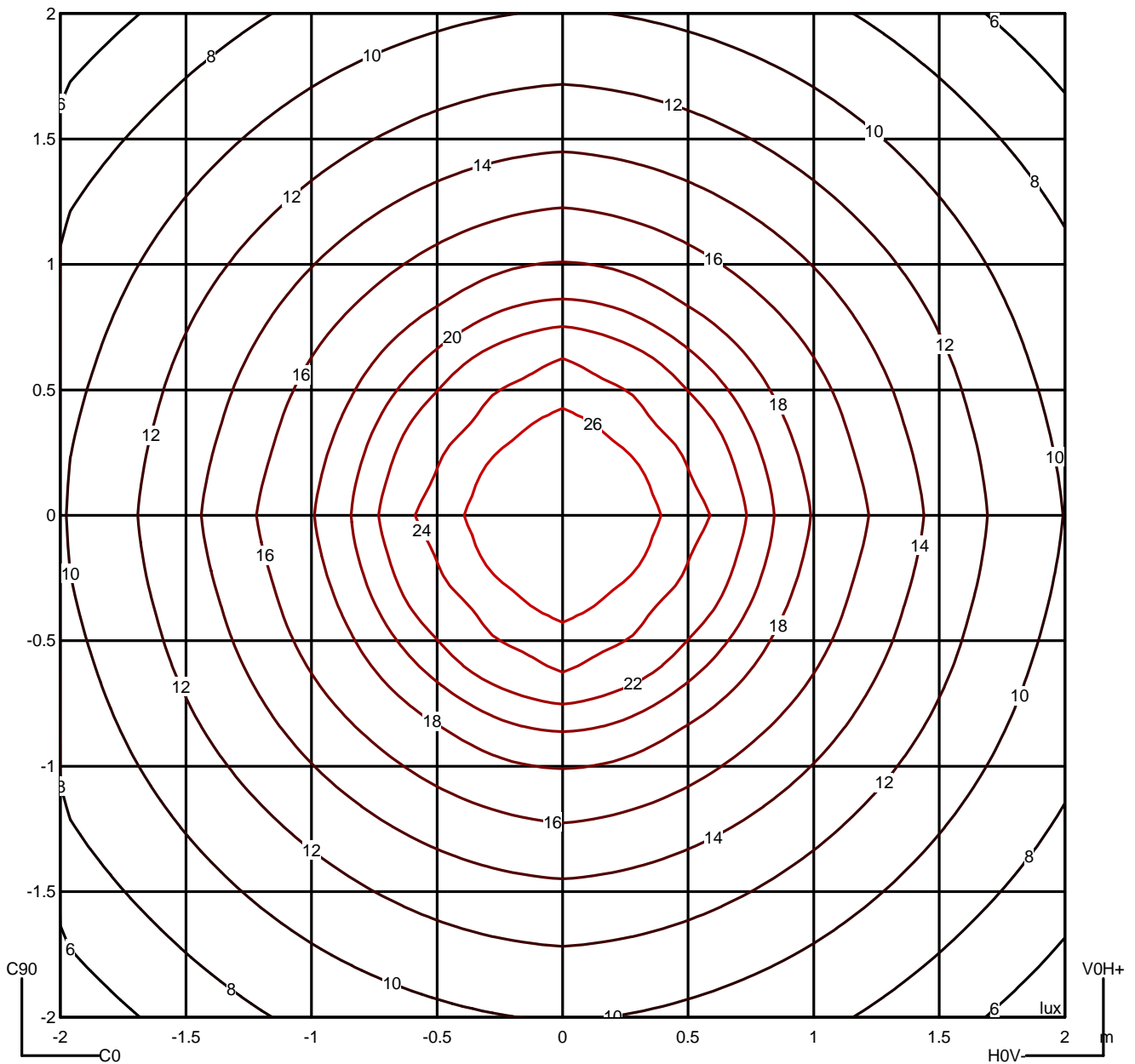

Luminaire

Code DE-0233-BLA
 Name Colgante FORLIGHT 60W E27

Measurment.

Code DE-0233-BLA
 Name Colgante FORLIGHT 60W E27

Luminaire Flux	416.89 lm	Luminaire Power	42.00 W	Efficacy	9.93 lm/W	Efficiency	66.17%
Lamps Flux	630.00 lm	Maximum value	399.36 cd/klm	Position	C=0.00 G=0.00	CG	Double Symmetrical

		Average Luminance [cd/m ²]									
		45°	50°	55°	60°	65°	70°	75°	80°	85°	
0.0°		2459	2036	1483	1410	1330	1174	1014	963	814	---
90.0°		2526	2059	1522	1419	1377	1152	1062	911	872	---

Flush mounted or longitudinal view												
		Illumination(lx)										
A	A	2000	1000	750	500		<300					1.15
B	1		2000	1500	1000	750	500	<300				1.5
C					2000		1000	500	<300			1.85
D	2						2000	1000	500	<300		2.2
E	3							2000	1000	500	<300	2.55

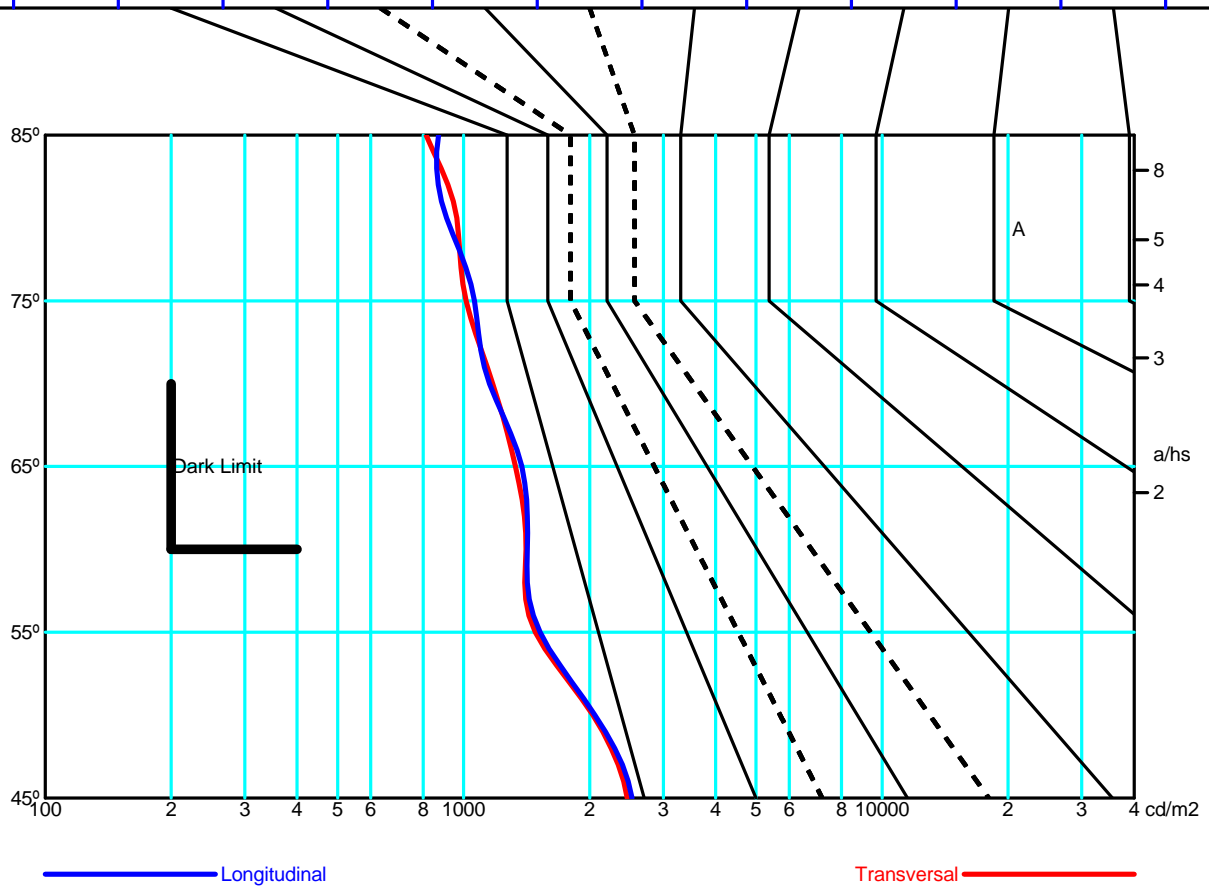

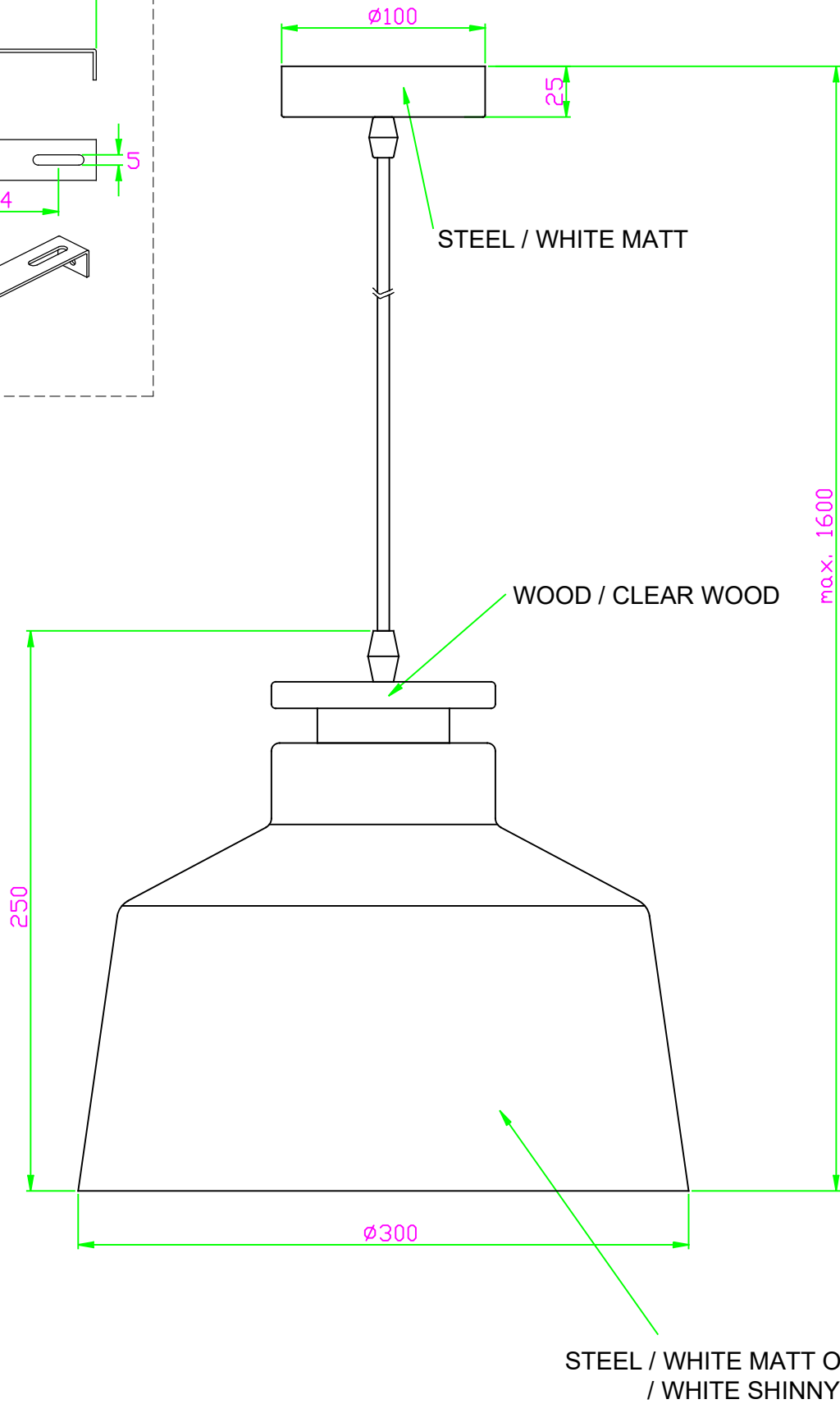
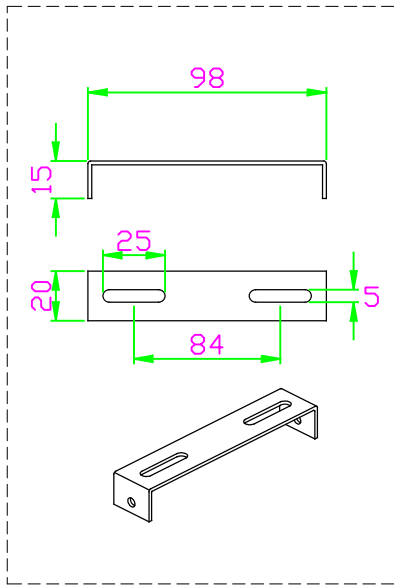

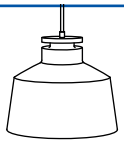

Nube

DE-0233 DE-0234 DE-0235

FOR
LIGHT

