

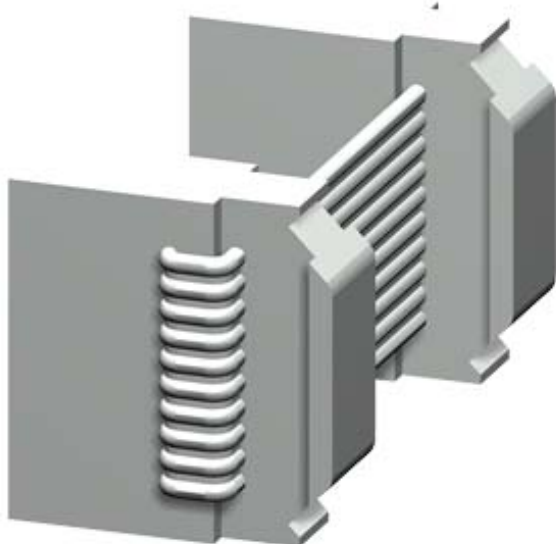





cable de enlace Longitud 0,1 m, plano, para conectar la unidad base, Módulo de medida de intensidad, módulo de medida de intensidad/tensión, bloque de control de operador o módulos de ampliación a través de la interfaz del sistema







### Datos técnicos generales:

Nombre comercial del producto	SIRIUS
Designación del producto	Cable de conexión
Tipo de producto	Longitud 0,1 m, plano
Temperatura ambiente	
• durante el almacenamiento	-40 ... +80 °C
• durante el funcionamiento	-25 ... +60 °C
• durante el transporte	-40 ... +80 °C

### Certificados/ Homologaciones:

General Product Approval			EMC	Declaration of Conformity	Test Certificates
 CSA	 UL		 RCM	 EG-Konf.	<a href="#">Type Test Certificates/Test Report</a>

Shipping Approval				other	
 ABS	 LRS	 PRS	 RMRS	<a href="#">Confirmation</a>	<a href="#">PROFIsafe-Certification</a>

other
<a href="#">PROFINET-Certification</a>  Profibus

### Más información

**Information- and Downloadcenter (Catálogos, Folletos,...)**

<http://www.siemens.com/industrial-controls/catalogs>

**Industry Mall (sistema de pedido online)**

<https://mall.industry.siemens.com/mall/es/es/Catalog/product?mlfb=3UF7931-0AA00-0>

**Generador CAX online**

<http://support.automation.siemens.com/WW/CAXorder/default.aspx?lang=en&mlfb=3UF7931-0AA00-0>

**Service&Support (Manuales, certificados, características, FAQ,...)**

<https://support.industry.siemens.com/cs/ww/es/ps/3UF7931-0AA00-0>

**Base de datos de imágenes (fotos de producto, dibujos acotados 2D, modelos 3D, esquemas de conexiones, macros**

**EPLAN, ...)**

[http://www.automation.siemens.com/bilddb/cax\\_de.aspx?mlfb=3UF7931-0AA00-0&lang=en](http://www.automation.siemens.com/bilddb/cax_de.aspx?mlfb=3UF7931-0AA00-0&lang=en)

