

Plug AM-TOP® - Part no. 294

- screw terminals
- single part body
- cable gland and sealing
- strain relief and protection against kinking

Technical information	
Ampere	32 A
Poles	4 p
Voltage	400 V
Earth position	6 h
Hertz	50-60 Hz
Connection technology	Screw terminals
Contact	standard
Protection type	IP 67

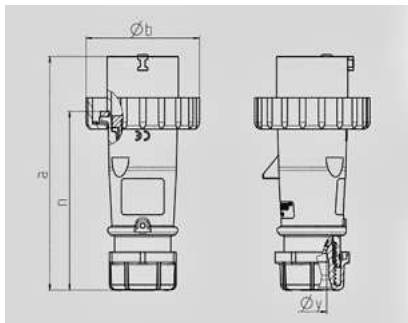

Drawing 2 MB 218	Amp. Poles	16			32		
		3	4	5	3	4	5
Dim. in mm	a	142	144	147	186	186	180
	b	70	78	87	94	94	101
	n	109	111	114	145	145	138
	y	14,5	16	16	22	22	22
	Terminal for cond. cross	1	1	1	2,5	2,5	2,5
	section (mm²) min.-max.	—2,5	—2,5	—2,5	—6	—6	—6