

Wall mounted receptacle - Part no. 9382



- screw terminals
- highly resistant to chemicals
- with 2 external fixing points
- enclosure base can be turned 180°
- receptacles are designed for adding an auxiliary contact switch

Technical information

Ampere	32 A
Poles	5 p
Voltage	400V
Earth position	6 h
Hertz	50-60 Hz
Connection technology	Screw terminals
Contact	standard
Protection type	IP 67

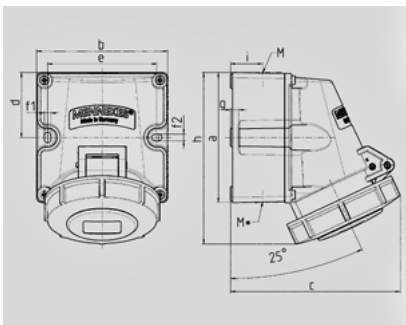

Drawing 1 MB 622	Amp. Poles	16			32		
		3	4	5	3	4	5
Dim. in mm	a	100	100	100	100	100	100
	b	101	101	101	109	109	109
	c	117	125	131	157	157	160
	d	50	50	50	50	50	50
	e	84	84	84	92	92	92
	f1	5,3	5,3	5,3	5,3	5,3	5,3
	f2	5,3	5,3	5,3	5,3	5,3	5,3
	g	6,5	6,5	6,5	6,5	6,5	6,5
	h	131	131	132	148	148	148
	i	24,7	24,7	24,7	27,5	27,5	27,5
	M	25 (optional M20)			32 (optional M25)		
	M*	2x25 (blind) to be cut out 18 (M25) and 15 (M20)			2x25 (blind) to be cut out 25 (M32) and 18 (M25)		
Max. cable diam. (mm)		1,5	1,5	1,5	2,5	2,5	2,5
Terminal for cond. cross section (mm²) min.-max.		-4	-4	-4	-6	-6	-6